



**ČAJAVEC**  
FABRIKA SIGNALNIH URE\AJA  
a.d. Laktaši

SIRENE



ELEKTRI^NE SIRENE  
ELECTRIC HORNS



Nosa - (Bracket)

- 1 Cinkovan (Zn plated)
- 2 Crno cinkovan (Black Zn plated)

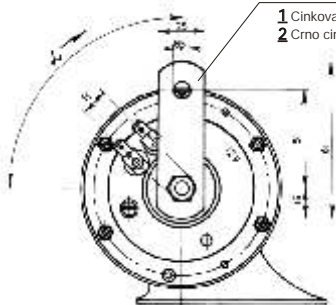

Nosa-I (Brackets)

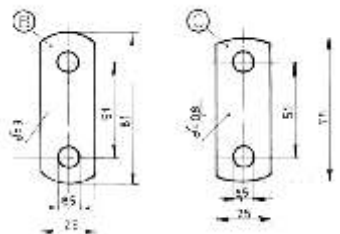
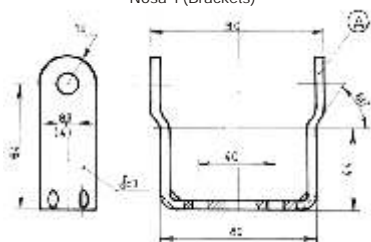

Tip Type	Ident gl. sklopa Assy ident	Br. priklju-aka Terminal	Nosa - tip Bracket - type	a (°)	Napon (V) Voltage (V)	Frekvencija (Hz) Tone freq. (Hz)	Snaga (W) Power (W)	Attest Ⓜ 01.88.001 eZ	Primjena Application	Uporedna oznaka Interchangeable with		
										BOSCH	HELLA	LUCAS
S02.1	513776	1	B2	90	12	500	70	+	Putni-ka vozila (YUGO 55GV) Passenger cars			
S02.2.01	780416	1	C2	180	12	500	70	+	Putni-ka vozila (YUGO FLORIDA) Passenger cars			
S02.3	514301	2	B2	90	12	500	70	+	Putni-ka vozila Passenger cars			21953724
S02.4	514302	2	B2	165	12	400	70	+	Putni-ka vozila Passenger cars			21953723
S02.5	514303	2	B2	90	24	500	70	+	Privredna vozila (kamioni i autobusi) Commercial vehicles (tracks and bus)			21953726
S02.6	514304	2	B2	165	24	400	70	+	Privredna vozila (kamioni i autobusi) Commercial vehicles (tracks and bus)			21953725
S02.7	514314	1	B2	90	12	500	70	+	Putni-ka vozila Passenger cars			



**ELEKTRI^NE SIRENE  
ELECTRIC HORNS**

Tip Type	Ident gl. sklopa Assy ident	Br. priklju-aka Terminal	Nos - tip Bracket - type	a (°)	Napon (V) Voltage (V)	Frekvencija (Hz) Tone freq. (Hz)	Snaga (W) Power (W)	Attest ® 01.88.001 eZ	Primjena Application	Uporedna oznaka Interchangeable with		
										BOSCH	HELLA	LUCAS
S02.8	514315	1	B2	135	12	400	70	+	Putni-ka vozila Passenger cars			
S02.9	514316	1	B2	90	24	500	70	+	Privredna vozila (kamioni i autobusi) Commercial vehicles (tracks and bus)			
S02.10	514317	1	B2	135	24	400	70	+	Privredna vozila (kamioni i autobusi) Commercial vehicles (tracks and bus)			
S02.11 (DAS 12V)	575268	1	-	-	12	400 500	70	+	Putni-ka vozila i gra evinske ma{ine Passenger cars and engineering machines			
S02.12 (DAS 24V)	575269	1	-	-	24	400 500	70	+	Privredna vozila (FAP i IKARBUS) Commercial vehicles			
S02.13 (DAS 12V)	510181	1	A1	-	12	400 500	70	+	Putni-ka vozila i gra evinske ma{ine Passenger cars and engineering machines			
S02.14 (DAS 24V)	512745	1	A1	-	24	400 500	70	+	Privredna vozila i gra evinske ma{ine Commercial vehicles and engineering machines			











ELEKTRI\NE SIRENE  
ELECTRIC HORNS

Tip Type	Ident. gl. sklopa Assy ident	Prijlu-ak Terminal	Ku\ite Housing	Nos- - tip Bracket - type	Napon (V) Voltage (V)	Frekvencija (Hz) Tone freq. (Hz)	Snaga (W) Power (W)	Attest (E) 921(EZ)	Primjena Application	Uparedna oznaka Interchangeable with				
										BOSCH	HELLA	KLAXON	MARELLI	LUCAS
S24	575496	3	I	A1	12	335	50	+	Putni-ka vozila (VW, OPEL, BMW, VOLVO) Passenger cars	0 320 043 005	3AL 02 98212			
S24.1	513208	3	I	B2	12	430	50	+	Putni-ka vozila (YUGO) Passenger cars				T12 EE/BB	
S24.1.01	514212	3	I	I2	12	430	50	+	Putni-ka vozila (YUGO TEMPO) Passenger cars					
S24.2	513127	2	II	E1	12	430	50	+	Putni-ka vozila (RENAULT-4) Passenger cars				T12 DE/E D12 DE/G	KM4
S24.3	514054	2	II	E1	12	335	50	+	Putni-ka vozila Passenger cars (RENAULT-4, CITROEN)				T12 DE/E D12 DE/E	KM4
S24.4	513345	1	II	D1	12	430	50	+	Putni-ka vozila (RENAULT-9) Passenger cars					
S24.5	513344	2	II	D1	12	335	50	+	Putni-ka vozila (RENAULT-9) Passenger cars					





**ELEKTRI^NE SIRENE**  
**ELECTRIC HORNS**

Tip Type	Ident gl. sklopa Assy ident	Prijlu-ak Terminal	Ku\ite Housing	Nos- - tip Bracket - type	Napon (V) Voltage (V)	Frekvencija (Hz) Tone freq. (Hz)	Snaga (W) Power (W)	Attest (E) 921[E]	Primjena Application	Uparedna oznaka Interchangeable with				
										BOSCH	HELLA	KLAXON	MARELLI	LUCAS
 S24.6	780067	3	I	M1	12	335	50	+	Putni-ka vozila i polj. ma{ine Passenger cars and agricultural machines	0 320 043 010				
 S24.7	780077	3	I	M1	12	430	50	+	Putni-ka vozila i polj. ma{ine Passenger cars and agricultural machines	0 320 043 011				
 S24.8	513404	2	II	C1	12	420	50	+	Putni-ka vozila ([KODA) Passenger cars					
 S24.9	513690	2	II	C1	12	350	50	+	Putni-ka vozila ([KODA) Passenger cars					
 S24.10	513975	2	II	J1	12	335	50	+	Putni-ka vozila Passenger cars					21953901
 S24.11	513976	2	II	J1	12	430	50	+	Putni-ka vozila Passenger cars					21953900
S24.12	514052	2	II	H1	12	430	50	+	Putni-ka vozila (RENAULT-5) Passenger cars					









**ELEKTRI^NE SIRENE  
ELECTRIC HORNS**

Tip Type	Ident. gl. sklopa Assy ident	Prijlu-ak Terminal	Ku\ite Housing	Nos- - tip Bracket - type	Napon (V) Voltage (V)	Frekvencija (Hz) Tone freq. (Hz)	Snaga (W) Power (W)	Attest (E) 921(EZ)	Primjena Application	Uporedna oznaka Interchangeable with				
										BOSCH	HELLA	KLAXON	MARELLI	LUCAS
S24.13	514053	1	II	H1	12	335	50	+	Putni-ka vozila (RENAULT-5) Passenger cars					
S24.14	513824	3	I	C2	12	335	50	+	Putni-ka vozila i polj. ma\ine Passenger cars and agricultural machines	0 320 043 010				
S24.15	513825	3	I	C2	12	430	50	+	Putni-ka vozila i polj. ma\ine Passenger cars and agricultural machines	0 320 043 011				
S24.16 (AB)	513805	3	I	C2	12	335 430	50	+	Putni-ka vozila Passenger cars	0 320 043 901				
S24.17	756385	3	I	P2	12	430	50	+	Putni-ka vozila (ZCZ - IVECO) Passenger cars					
S24.18	514460	5	III	K1	12	335	50	+	Putni-ka vozila Passenger cars					
S24.19	514137	4	III	M2	12	335	50	+	Putni-ka vozila (MERCEDES) Passenger cars					











**ELEKTRI\NE SIRENE**  
**ELECTRIC HORNS**

Tip Type	Ident. gl. sklopa Assy ident	Prijlu-ak Terminal Housing	Nos- - tip Bracket - type	Napon (V) Voltage (V)	Frekvencija (Hz) Tone freq. (Hz)	Snaga (W) Power (W)	Attest (E) 921(EZ)	Primjena Application	Uporedna oznaka Interchangeable with						
									BOSCH	HELLA	KLAXON	MARELLI	LUCAS		
	S24.20	514138	4	III	M2	12	430	50	+	Putni-ka vozila (MERCEDES) Passenger cars					
	S24.21	514059	2	II	G1	12	430	50	+	Putni-ka vozila Passenger cars					
	S24.24	514297	2	II	J1	12	335	50	+	Putni-ka vozila Passenger cars					
	S24.25	514298	2	II	J1	12	335	50	+	Putni-ka vozila Passenger cars					
	S24.26	514299	3	I	J1	12	335	50	+	Putni-ka vozila Passenger cars					
	S24.27	514300	3	I	J1	12	430	50	+	Putni-ka vozila Passenger cars					
	S24.28	514458	3	I	L1	12	335	50	+	Putni-ka vozila Passenger cars					



**ELEKTRI^NE SIRENE**  
**ELECTRIC HORNS**

Tip Type	Ident gl. sklopa Assy ident	Priklju-ak Terminal Housing	Nos- - tip Bracket - type	Napon (V) Voltage (V)	Frekvencija (Hz) Tone freq. (Hz)	Snaga (W) Power (W)	Attest (E) 921[EZ]	Primjena Application	Uporedna oznaka Interchangeable with						
									BOSCH	HELLA	KLAXON	MARELLI	LUCAS		
	S24.29	514462	3	I	M1	12	430	50	+	Putni-ka vozila i polj. mašine Passenger cars and agricultural machines	0 320 043 011				
	S24.30	514506	2	III	M2	12	430	50	+	Putni-ka vozila Passenger cars					
	S24.31	514507	3	I	M2	12	430	50	+	Putni-ka vozila Passenger cars					
	S24.32	514465	3	I	N1	12	430	50	+	Putni-ka vozila Passenger cars					
	S24.91	514021	2	II	C1	24	335	50	+	Privredna vozila Commercial vehicles					
	S24.92	514293	2	II	J1	24	335	50	+	Privredna vozila Commercial vehicles					
	S24.93	514294	2	II	J1	24	430	50	+	Privredna vozila Commercial vehicles					







ELEKTRI^NE SIRENE  
ELECTRIC HORNS

PRIKLJU^AK (TERMINAL)

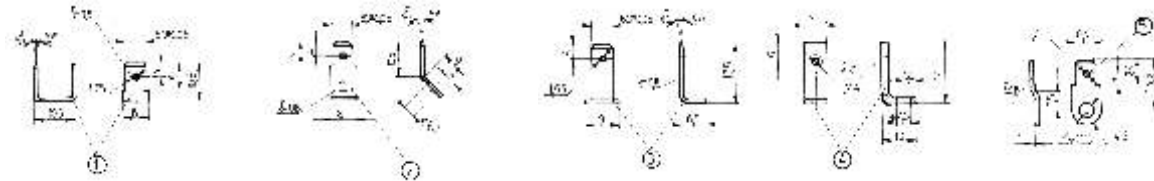
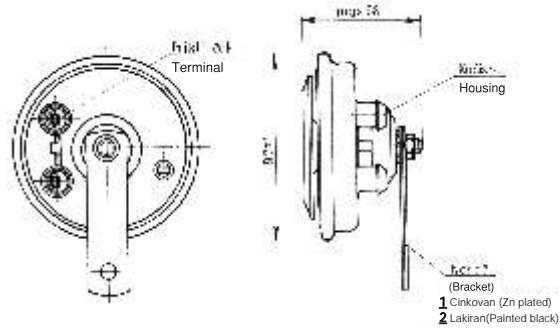

NOSA^ (BRACKET)

KU]I]TE (HOUSING)

NOSA^I ZA BRUJALICE  
(BRACKETS FOR BUZZERS)

